

MS201 x 4



MS053 x 2



MS181 x 2



MS176 x 2

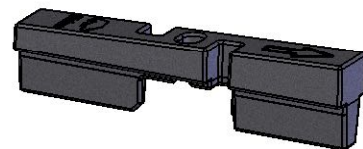

PS040 x 4

(1:1)

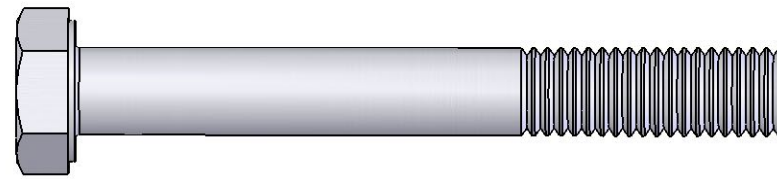

FB003 (M8 x 65) x 8

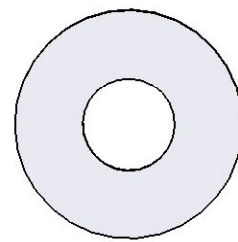

FW002 (M8) x 16



FN006 (M8) x 8

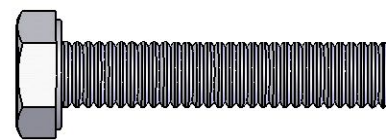

FS039 (M6 x 30) x 4

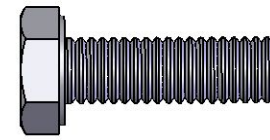

FS001 (M6 x 20) x 4

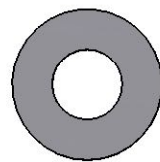

FW001 (M6) x 12

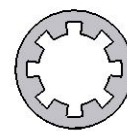

FW008 (M6) x 4

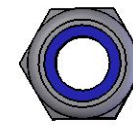

FN001 (M6) x 4

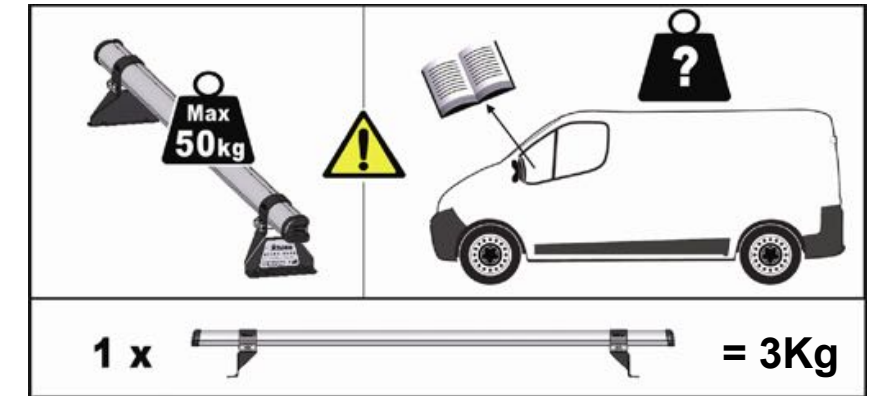

10mm x 2



12mm x 2

