

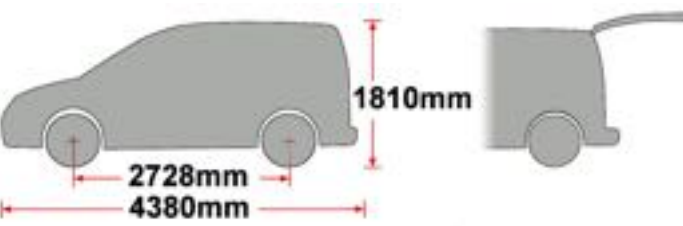
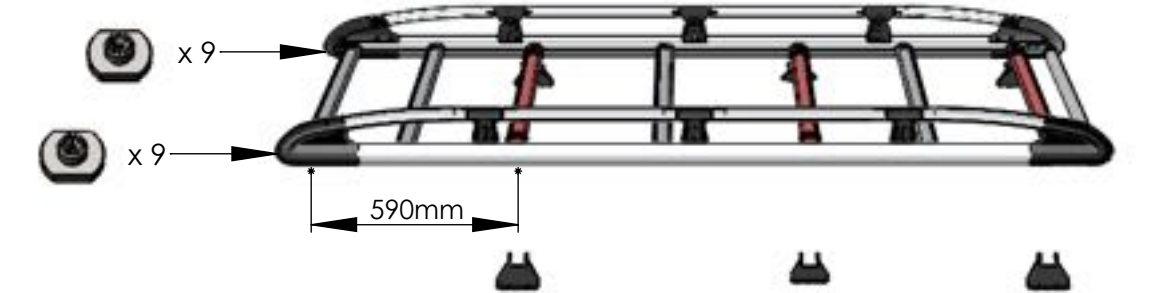

| | | |
|---|---|---|
| <h2 style="text-align: center;">A590</h2>  <p style="text-align: center;">29kg</p> | <h3 style="text-align: center;">BERLINGO/PARTNER 2008- L1, H1, TWIN DOORS</h3>  |  |
|---|---|---|

| | | |
|--|--|---|
| <h2 style="text-align: center;">A592</h2>  <p style="text-align: center;">28kg</p> | <h3 style="text-align: center;">BERLINGO/PARTNER 2008- L1, H1, TAILGATE</h3>  |  |
|--|--|---|

| | | |
|---|---|---|
| <h2 style="text-align: center;">A591</h2>  <p style="text-align: center;">32kg</p> | <h3 style="text-align: center;">BERLINGO/PARTNER 2008- L2, H1, TWIN DOORS</h3>  |  |
|---|---|---|

| | | |
|---|---|---|
| <h2 style="text-align: center;">A593</h2>  <p style="text-align: center;">29kg</p> | <h3 style="text-align: center;">BERLINGO/PARTNER 2008- L2, H1, TAILGATE</h3>  |  |
|---|---|---|

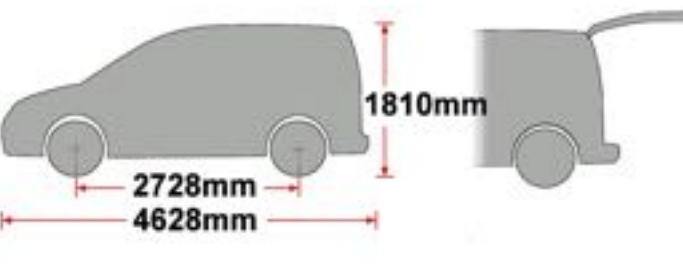
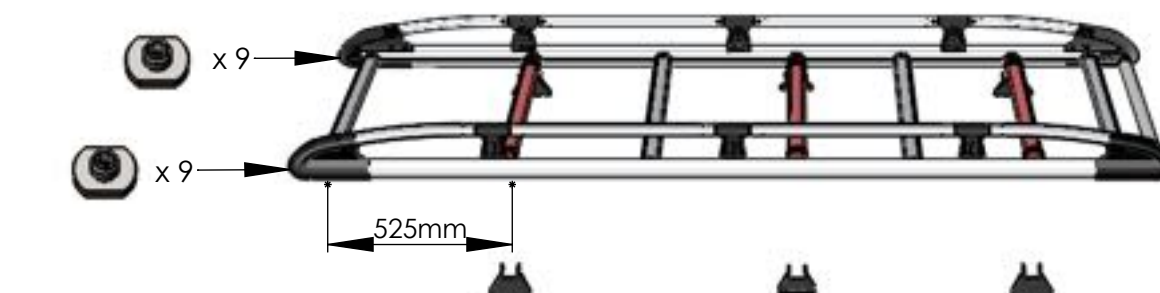
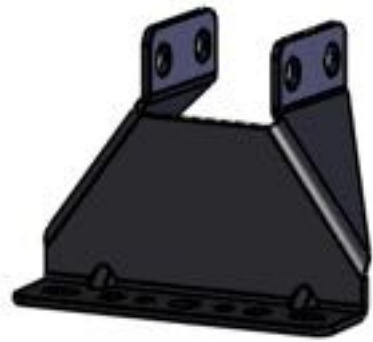

MS168 x 4



EXT09-004 x 6

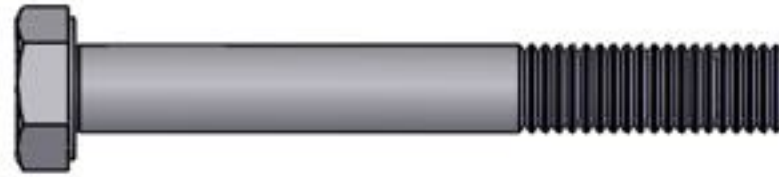

FB012 (M8 x 65) x 12

(1:1)

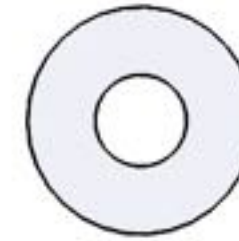

FW002 (M8) x 30



FN006 (M8) x 12

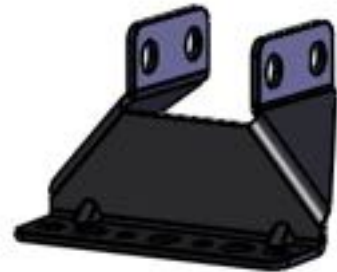

MS176 x 2



PS089 x 1



FS066 (M8 x 40) x 2



FS062 (M8 x 25) x 4



FW009 (M8) x 6



PS096 x 2



PS090 x 1



FS059 (M8 x 25) x 18

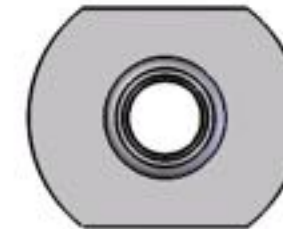

FN023 (M8) x 18



PS095 x 4



PS053 x 2

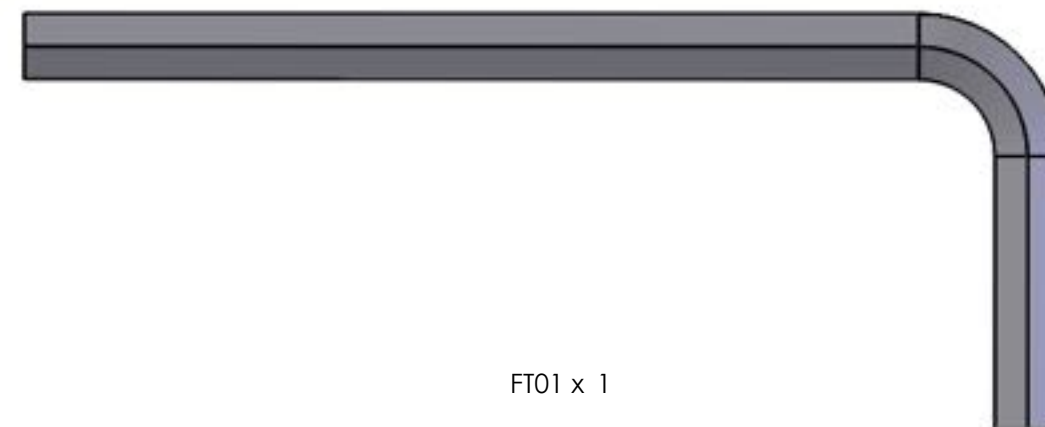

FT01 x 1



13mm x 2

