

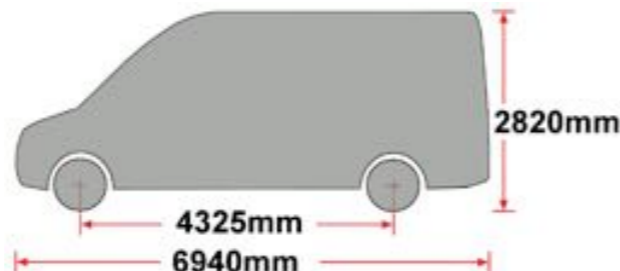

<h1>A521</h1>  <p>55kg + xx kg = Max. 150kg</p>	<h2>SPRINTER/CRAFTER 2006-L3, H2, TWIN DOORS</h2>  <p>4325mm 6940mm 2820mm</p>	<p>AMP20 + AMP24 = 4.4m</p>  <p>x 13 (F) (R)</p>
--	--	---

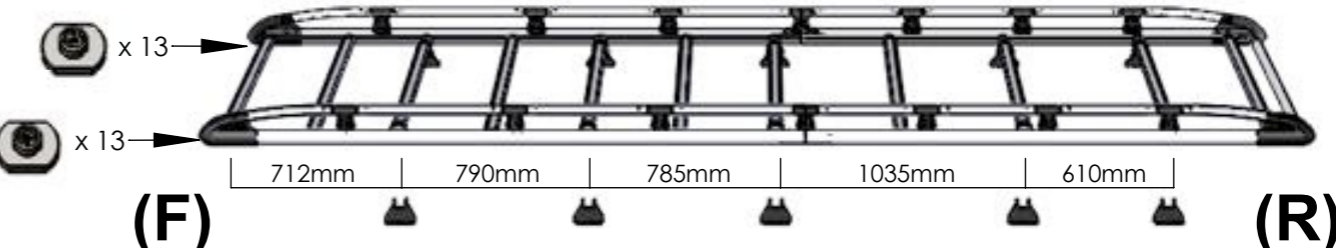

<h1>A522</h1>  <p>59kg + xx kg = Max. 150kg</p>	<h2>SPRINTER/CRAFTER 2006-L4, H2, TWIN DOORS</h2>  <p>4325mm 7345mm 2820mm</p>	<p>AMP24 + AMP24 = 4.8m</p>  <p>x 14 (F) (R)</p>
--	--	---

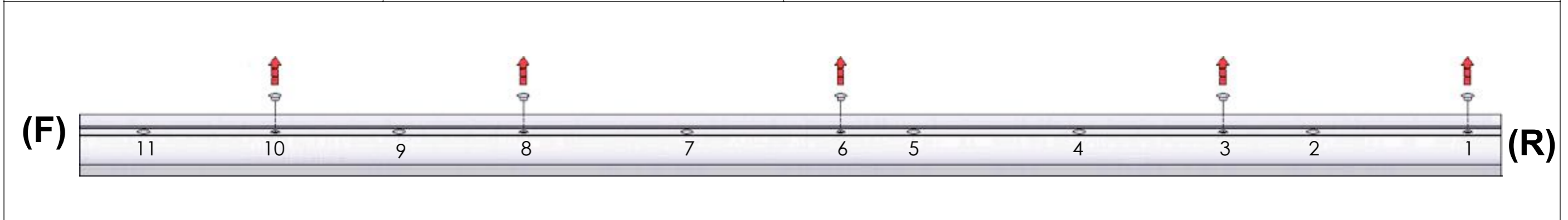

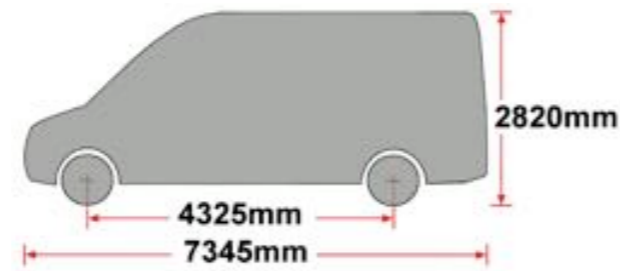
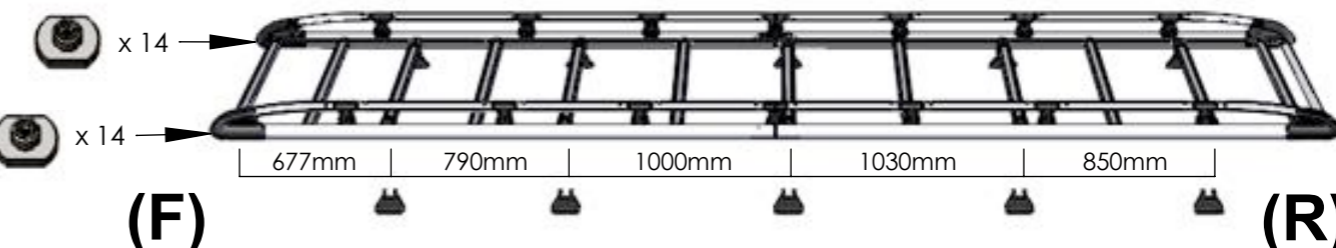
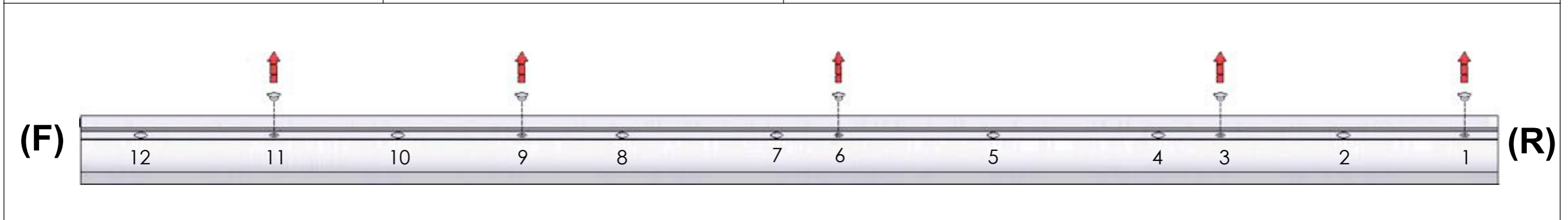

EXT09-004 x 10



MS168 x 10



PS095 x 10



PS089 x 1



PS090 x 1



PS023 x 10



FB012 (M8 x 65) x 20



FS062 (M8 x 25) x 10

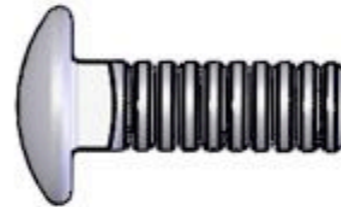

FS064 (M8 x 25) x 10



FS059 (M8 x 25) x 34

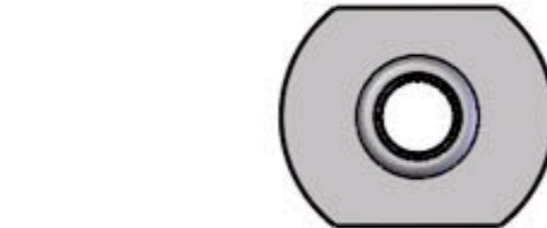

FN023 (M8) x 28

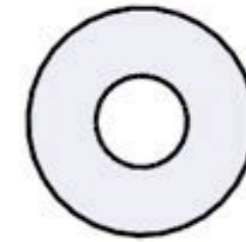

FW002 (M8) x 50



FN006 (M8) x 32

(1:1)

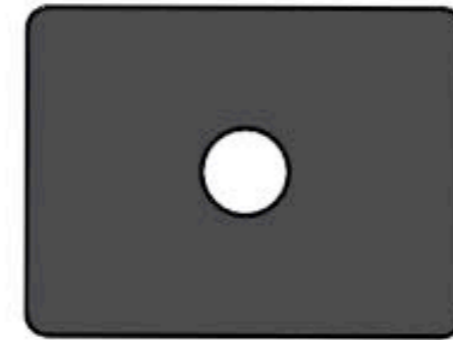

PS020 x 10

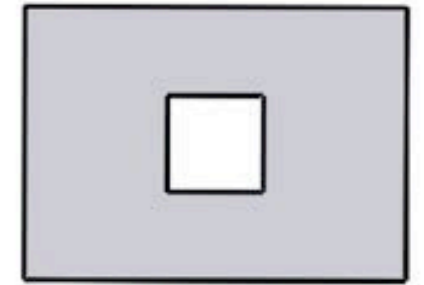

MS209 x 10



FS074 (M8 x 20) x 4

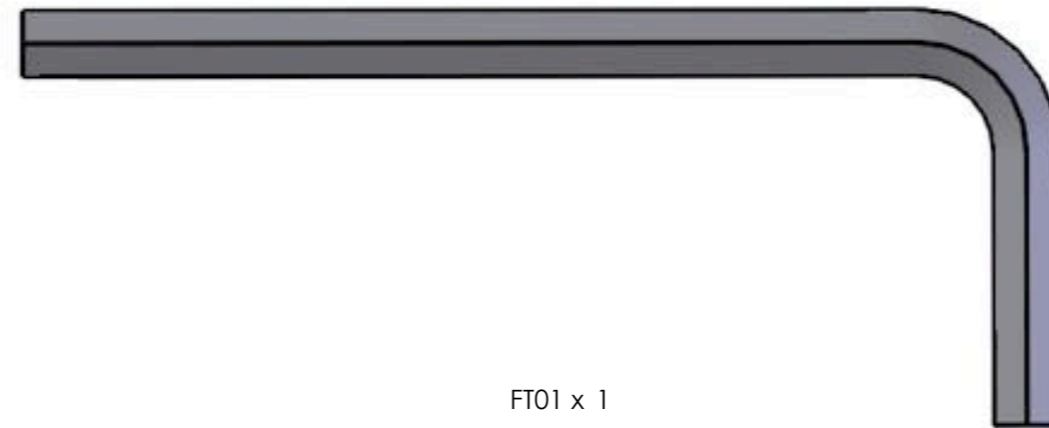

FT01 x 1



13mm x 2

