

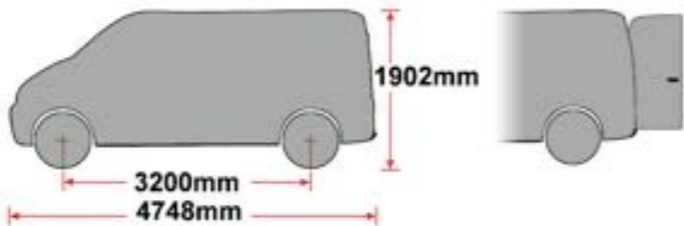

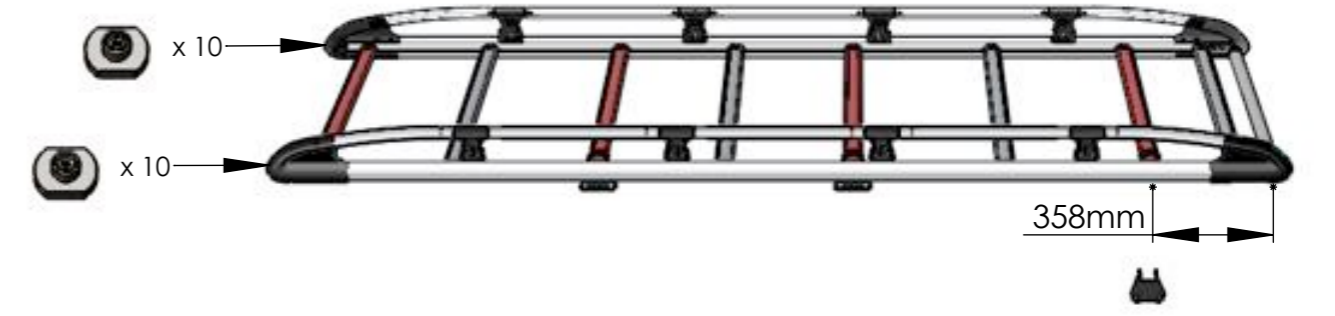





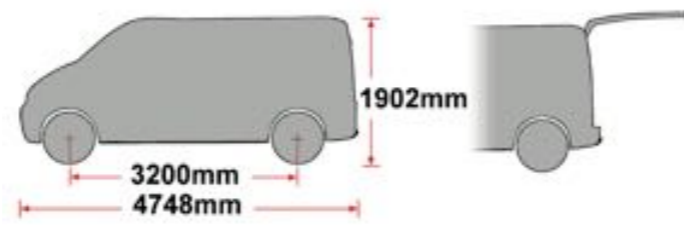
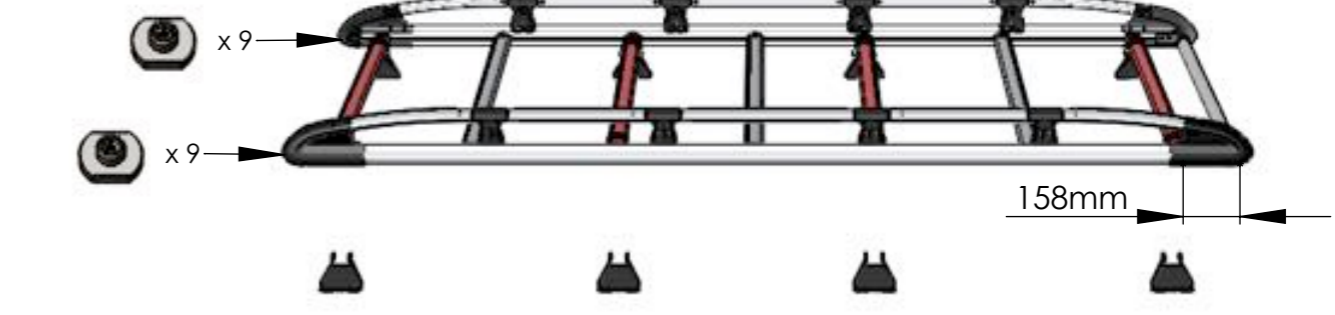

<h2 style="text-align: center;">A511</h2>  <p style="text-align: center;">35kg</p>	<h3 style="text-align: center;">VITO 2003-2015 L1, H1, TWIN DOORS</h3> 	
---	---	---

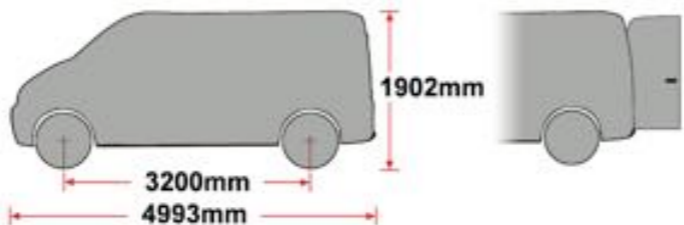
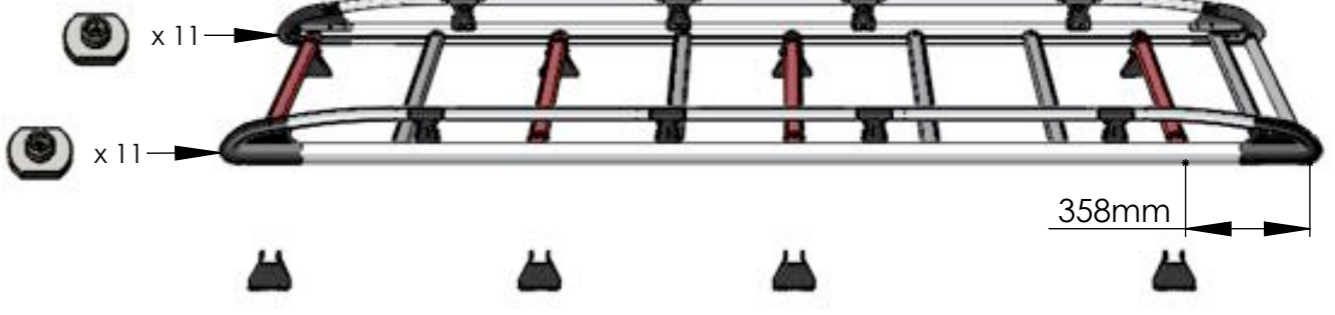
<h2 style="text-align: center;">A512</h2>  <p style="text-align: center;">32kg</p>	<h3 style="text-align: center;">VITO 2003-2015 L1, H1, TAILGATE</h3> 	
--	--	--

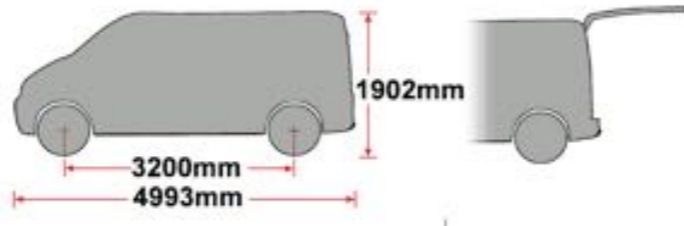
<h2 style="text-align: center;">A513</h2>  <p style="text-align: center;">38kg</p>	<h3 style="text-align: center;">VITO 2003-2015 L2, H1, TWIN DOORS</h3> 	
---	---	---

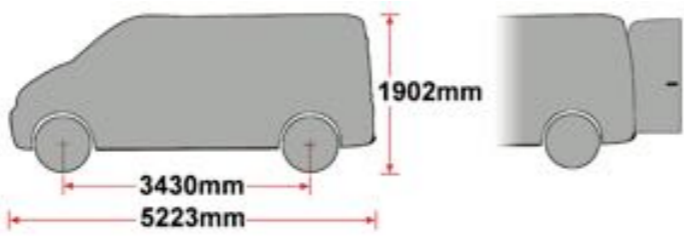
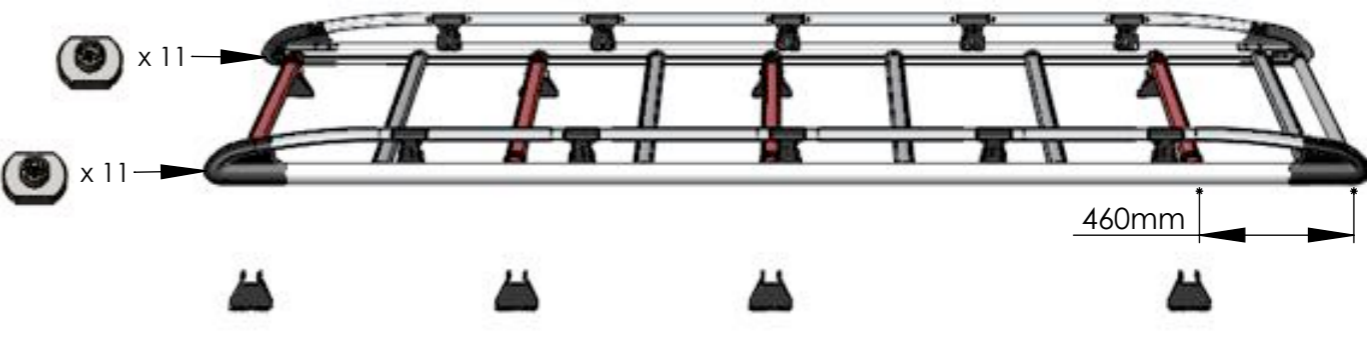
<h2 style="text-align: center;">A514</h2>  <p style="text-align: center;">35kg</p>	<h3 style="text-align: center;">VITO 2003-2015 L2, H1, TAILGATE</h3> 	
---	---	---

<h1>A515</h1>  <p>39kg + xx kg = Max. 150kg</p>	<h2>VITO 2003-2015 L3, H1, TWIN DOORS</h2>  <p>3430mm 5223mm 1902mm</p>	 <p>x 11 x 11 460mm</p>
--	---	--

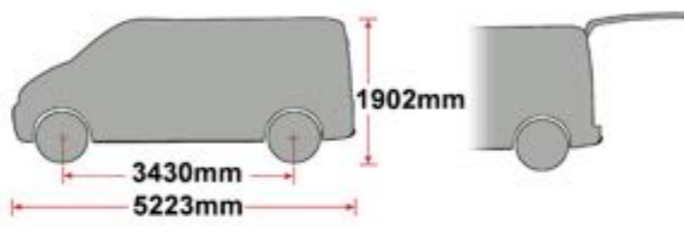
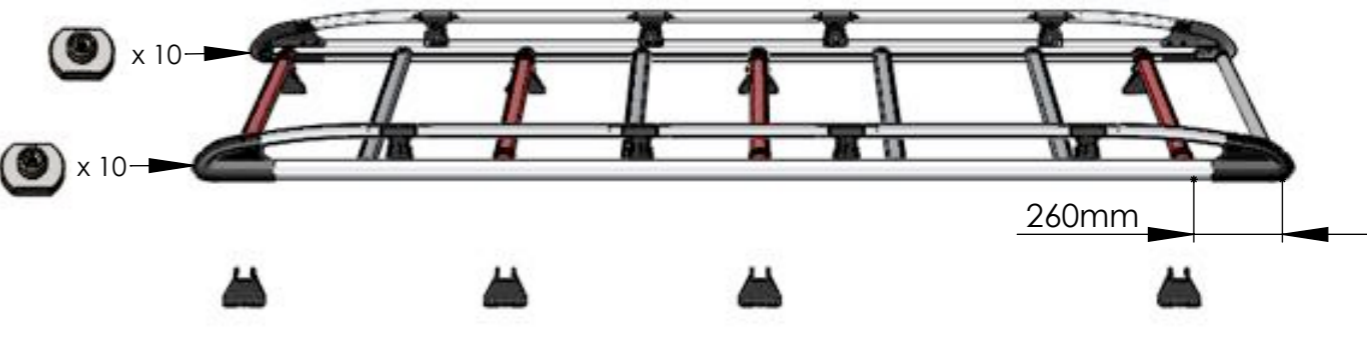
<h1>A516</h1>  <p>36kg + xx kg = Max. 150kg</p>	<h2>VITO 2003-2015 L3, H1, TAILGATE</h2>  <p>3430mm 5223mm 1902mm</p>	 <p>x 10 x 10 260mm</p>
---	--	---

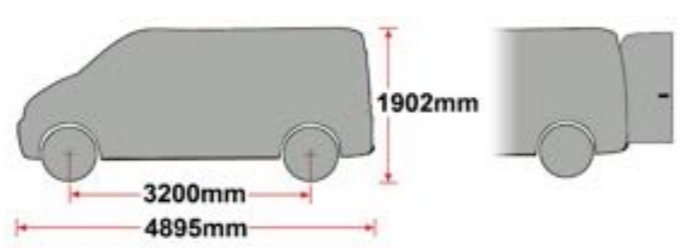
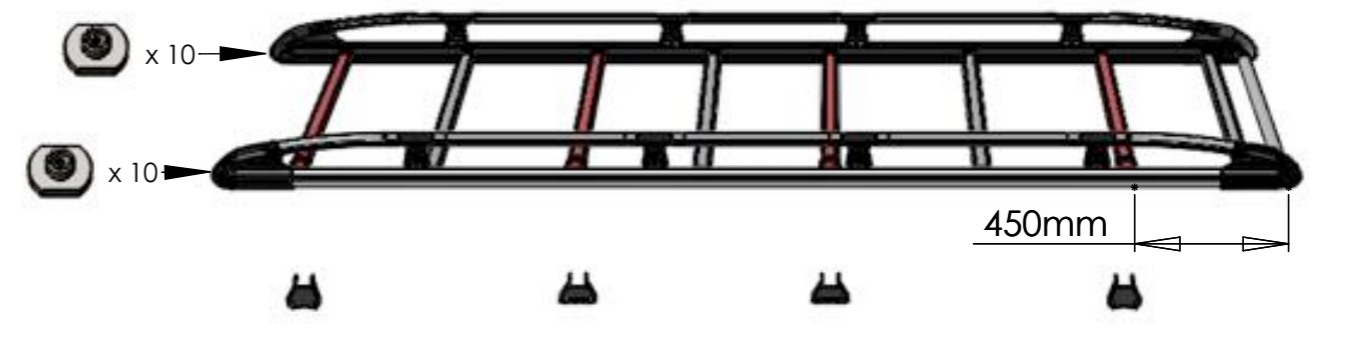
<h1>A643</h1>  <p>35kg + xx kg = Max. 150kg</p>	<h2>VITO 2015- L1, H1, TWIN DOORS</h2>  <p>3200mm 4895mm 1902mm</p>	 <p>x 10 x 10 450mm</p>
--	---	--

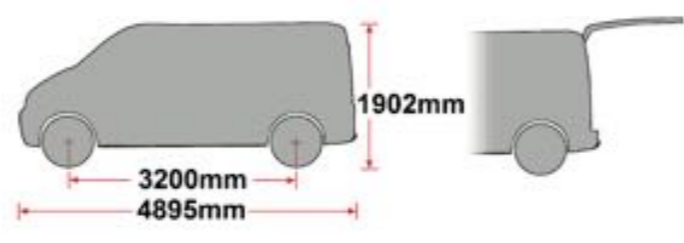
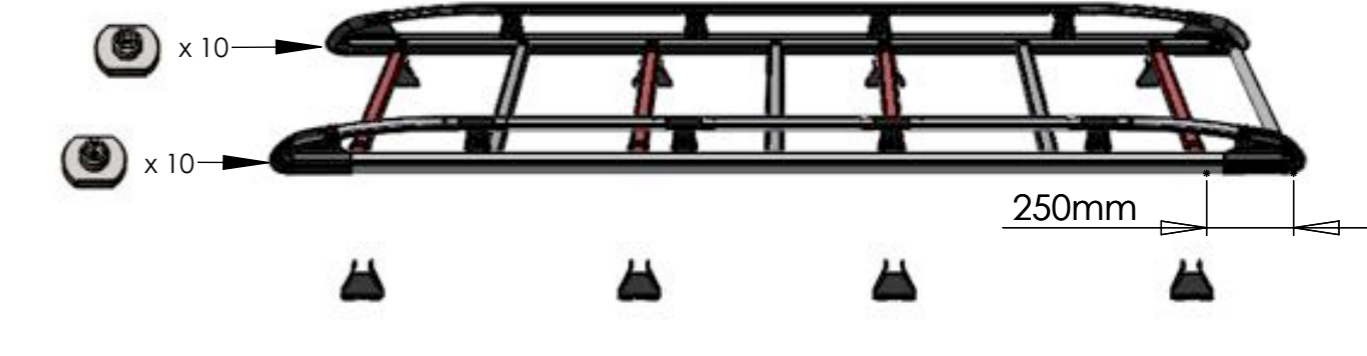
<h1>A644</h1>  <p>34kg + xx kg = Max. 150kg</p>	<h2>VITO 2015- L1, H1, TAILGATE</h2>  <p>3200mm 4895mm 1902mm</p>	 <p>x 10 x 10 250mm</p>
--	---	--

<h1>A645</h1> <p>40kg + xx kg = Max. 150kg</p>	<h2>VITO 2015- L2, H1, TWIN DOORS</h2> <p>3200mm 1902mm 5140mm</p>	<p>x 11 x 11 450mm</p>
--	--	--------------------------------

<h1>A646</h1> <p>37kg + xx kg = Max. 150kg</p>	<h2>VITO 2015- L2, H1, TAILGATE</h2> <p>3200mm 1902mm 5140mm</p>	<p>x 10 x 10 250mm</p>
--	--	--------------------------------

<h1>A647</h1> <p>41kg + xx kg = Max. 150kg</p>	<h2>VITO 2015- L3, H1, TWIN DOORS</h2> <p>3430mm 1902mm 5370mm</p>	<p>x 11 x 11 550mm</p>
--	--	--------------------------------

<h1>A648</h1> <p>38kg + xx kg = Max. 150kg</p>	<h2>VITO 2015- L3, H1, TAILGATE</h2> <p>3430mm 1902mm 5370mm</p>	<p>x 10 x 10 350mm</p>
--	--	--------------------------------

MS176 x 4



EXT09-004 x 8

MS259R x 1



PS089 x 1

MS259L x 1



PS090 x 1

MS260R x 1



MS019 x 6

?

PS046 x 8

MS260L x 1

(1:1)



FB03 (M8 x 65) x 16

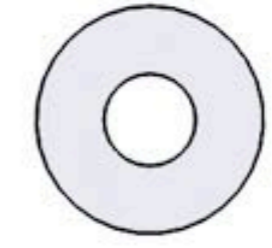

FW002 (M8) x 32



FN006 (M8) x 16



FS038 (M6 x 25) x 16



FS041 (M6 x 16) x 16

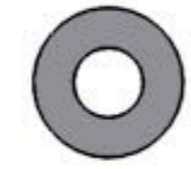

FW001 (M6) x 32



FW008 (M6) x 16



FN001 (M6) x 16



FS059 (M8 x 25) x 22

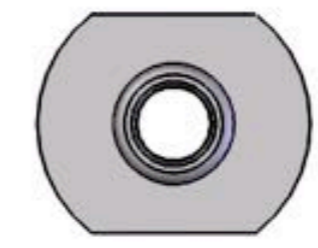

FN023 (M8) x 22

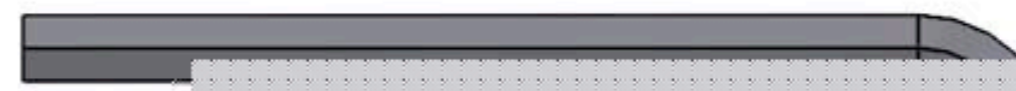

13mm x 2



10mm x 2

