

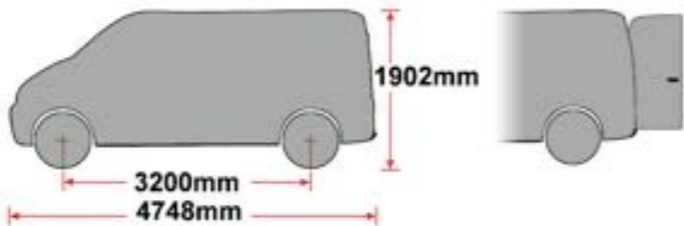

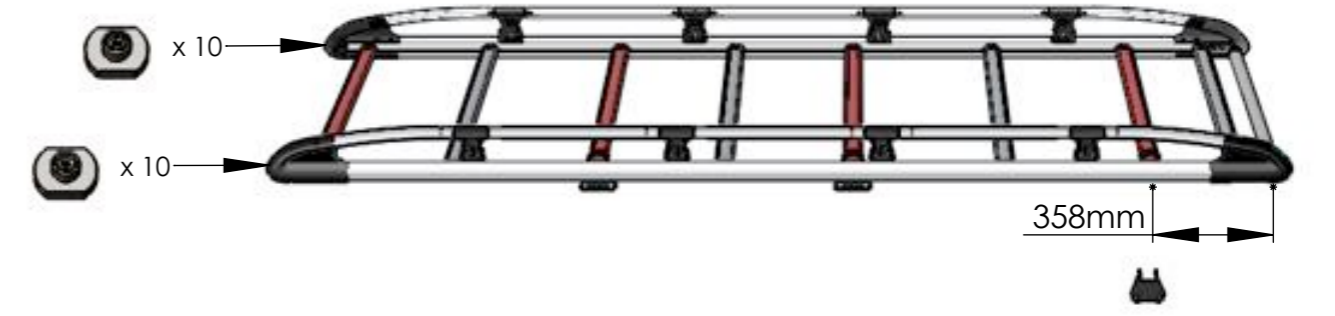





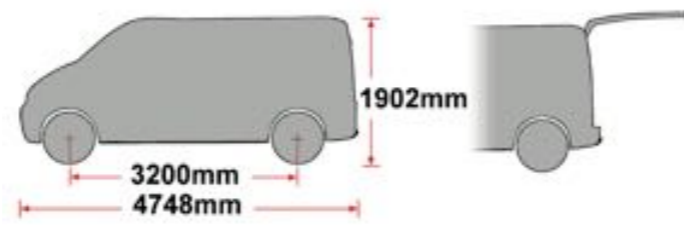
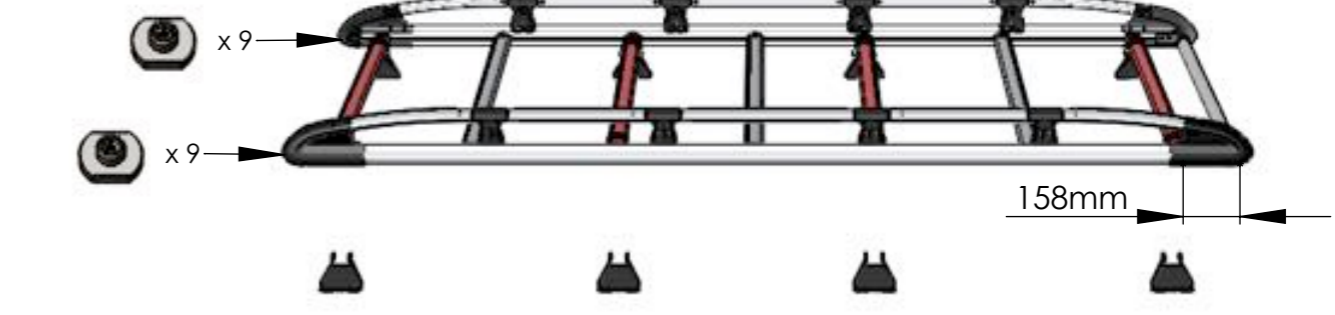

|  |   |  |
|--|---|--|
| <h2 style="text-align: center;">A511</h2>  <p style="text-align: center;">35kg + xx kg = Max. 150kg</p> | <h3 style="text-align: center;">VITO 2003-2015<br/>L1, H1, TWIN DOORS</h3>  <p style="text-align: center;">3200mm<br/>4748mm<br/>1902mm</p> |  <p style="text-align: center;">x 10<br/>x 10<br/>358mm</p> |
|--|---|--|

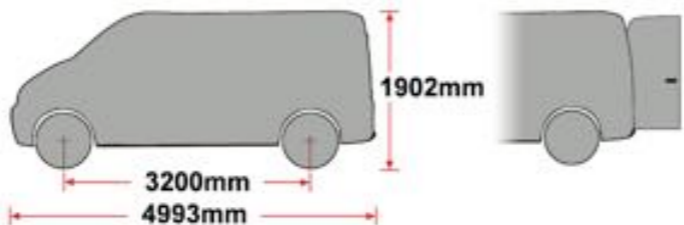
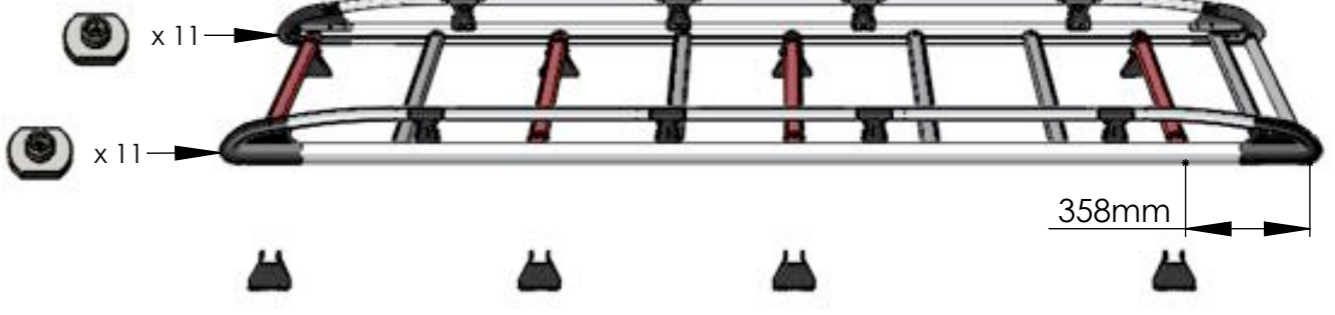
|   |  |   |
|---|--|---|
| <h2 style="text-align: center;">A512</h2>  <p style="text-align: center;">32kg + xx kg = Max. 150kg</p> | <h3 style="text-align: center;">VITO 2003-2015<br/>L1, H1, TAILGATE</h3>  <p style="text-align: center;">3200mm<br/>4748mm<br/>1902mm</p> |  <p style="text-align: center;">x 9<br/>x 9<br/>158mm</p> |
|---|--|---|

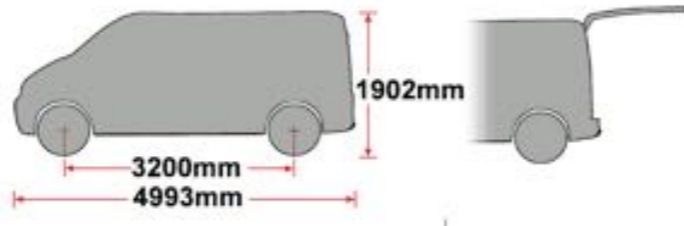
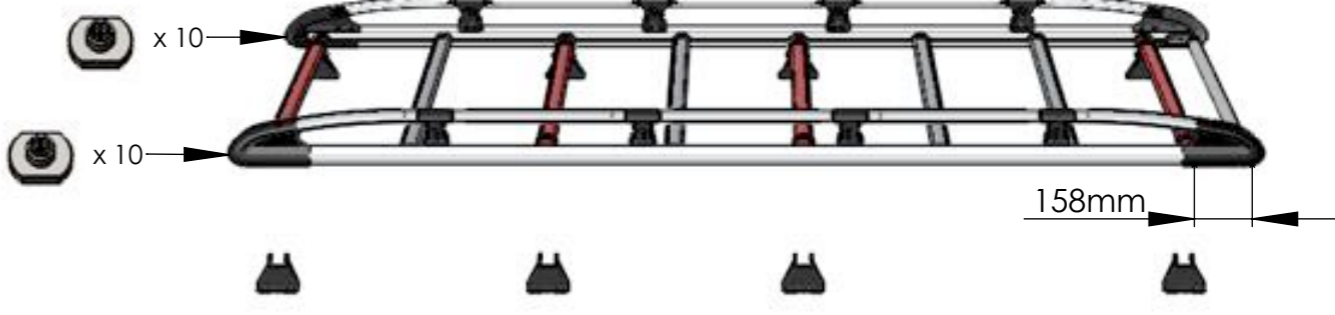
|  |   |  |
|--|---|--|
| <h2 style="text-align: center;">A513</h2>  <p style="text-align: center;">38kg + xx kg = Max. 150kg</p> | <h3 style="text-align: center;">VITO 2003-2015<br/>L2, H1, TWIN DOORS</h3>  <p style="text-align: center;">3200mm<br/>4993mm<br/>1902mm</p> |  <p style="text-align: center;">x 11<br/>x 11<br/>358mm</p> |
|--|---|--|

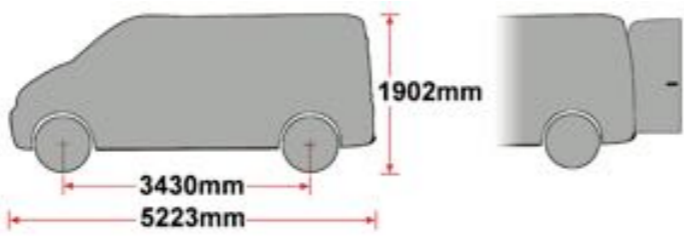
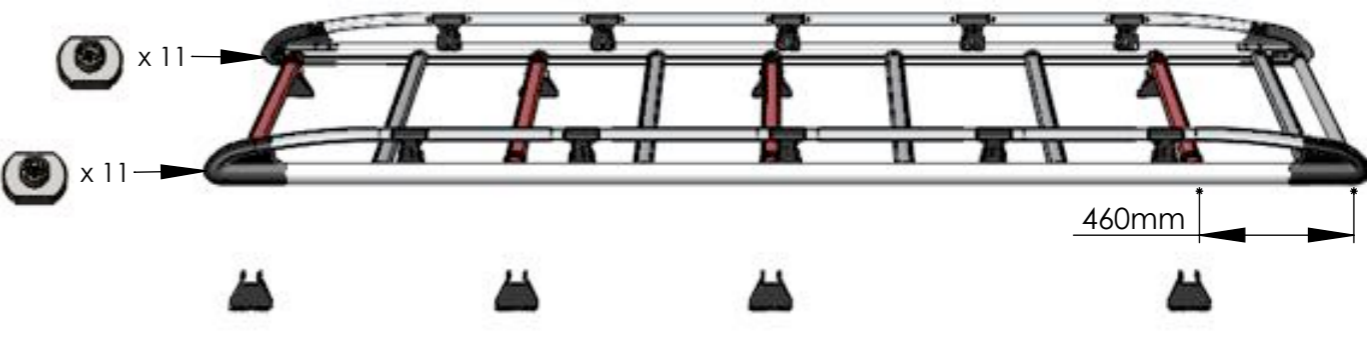
|  |   |  |
|--|---|--|
| <h2 style="text-align: center;">A514</h2>  <p style="text-align: center;">35kg + xx kg = Max. 150kg</p> | <h3 style="text-align: center;">VITO 2003-2015<br/>L2, H1, TAILGATE</h3>  <p style="text-align: center;">3200mm<br/>4993mm<br/>1902mm</p> |  <p style="text-align: center;">x 10<br/>x 10<br/>158mm</p> |
|--|---|--|

|  |   |  |
|--|---|--|
| <h1>A515</h1>  <p>39kg + xx kg = Max. 150kg</p> | <h2>VITO 2003-2015<br/>L3, H1, TWIN DOORS</h2>  <p>1902mm<br/>3430mm<br/>5223mm</p> |  <p>x 11<br/>x 11<br/>460mm</p> |
|--|---|--|

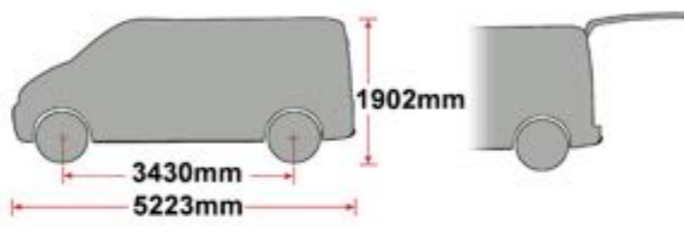
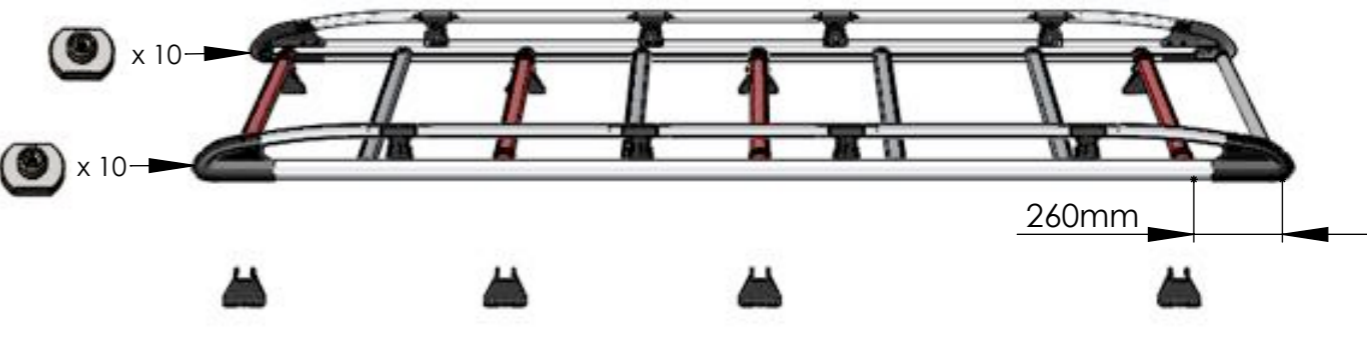
|   |  |  |
|---|--|--|
| <h1>A516</h1>  <p>36kg + xx kg = Max. 150kg</p> | <h2>VITO 2003-2015<br/>L3, H1, TAILGATE</h2>  <p>1902mm<br/>3430mm<br/>5223mm</p> |  <p>x 10<br/>x 10<br/>260mm</p> |
|---|--|--|

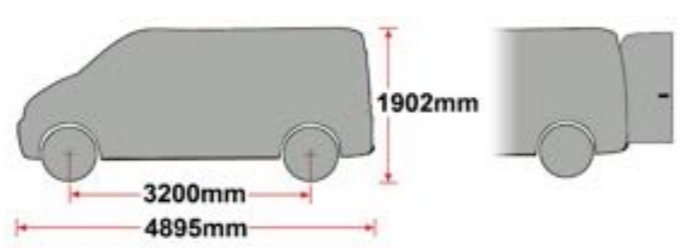
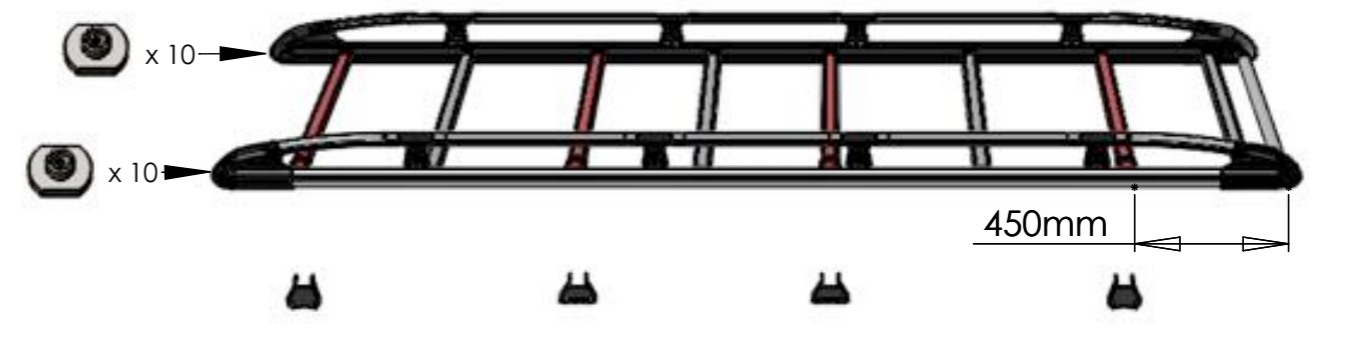
|  |   |  |
|--|---|--|
| <h1>A643</h1>  <p>35kg + xx kg = Max. 150kg</p> | <h2>VITO 2015-<br/>L1, H1, TWIN DOORS</h2>  <p>1902mm<br/>3200mm<br/>4895mm</p> |  <p>x 10<br/>x 10<br/>450mm</p> |
|--|---|--|

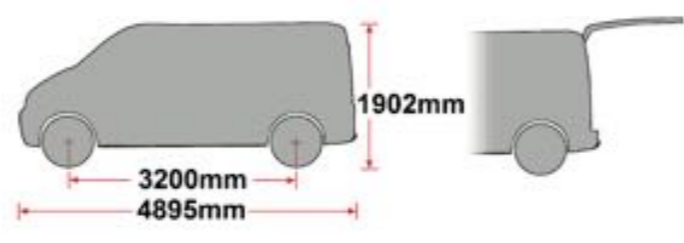
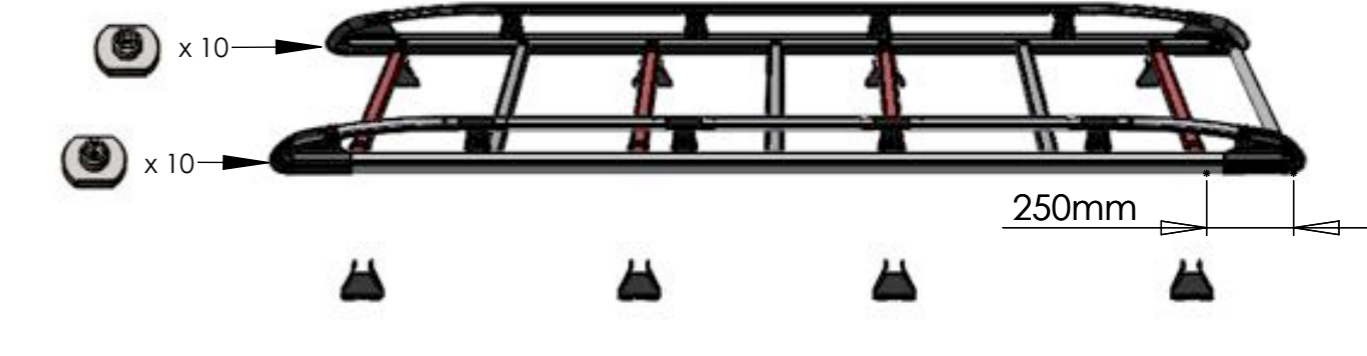
|  |   |  |
|--|---|--|
| <h1>A644</h1>  <p>34kg + xx kg = Max. 150kg</p> | <h2>VITO 2015-<br/>L1, H1, TAILGATE</h2>  <p>1902mm<br/>3200mm<br/>4895mm</p> |  <p>x 10<br/>x 10<br/>250mm</p> |
|--|---|--|

|  |  |                                |
|--|--|--------------------------------|
| <h1>A645</h1> <p>40kg + xx kg = Max. 150kg</p> | <h2>VITO 2015-<br/>L2, H1, TWIN DOORS</h2> <p>3200mm<br/>5140mm<br/>1902mm</p> | <p>x 11<br/>x 11<br/>450mm</p> |
|--|--|--------------------------------|

|  |  |                                |
|--|--|--------------------------------|
| <h1>A646</h1> <p>37kg + xx kg = Max. 150kg</p> | <h2>VITO 2015-<br/>L2, H1, TAILGATE</h2> <p>3200mm<br/>5140mm<br/>1902mm</p> | <p>x 10<br/>x 10<br/>250mm</p> |
|--|--|--------------------------------|

|  |  |                                |
|--|--|--------------------------------|
| <h1>A647</h1> <p>41kg + xx kg = Max. 150kg</p> | <h2>VITO 2015-<br/>L3, H1, TWIN DOORS</h2> <p>3430mm<br/>5370mm<br/>1902mm</p> | <p>x 11<br/>x 11<br/>550mm</p> |
|--|--|--------------------------------|

|  |  |                                |
|--|--|--------------------------------|
| <h1>A648</h1> <p>38kg + xx kg = Max. 150kg</p> | <h2>VITO 2015-<br/>L3, H1, TAILGATE</h2> <p>3430mm<br/>5370mm<br/>1902mm</p> | <p>x 10<br/>x 10<br/>350mm</p> |
|--|--|--------------------------------|

MS176 x 4



EXT09-004 x 8



FB003 (M8 x 65) x 16

(1:1)

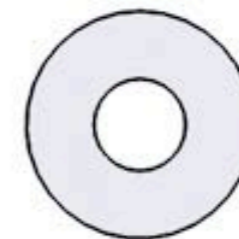

FW002 (M8) x 32



FN006 (M8) x 16

MS259R x 1



PS089 x 1



FS038 (M6 x 25) x 16



FS041 (M6 x 16) x 16



FW001 (M6) x 32



FW008 (M6) x 16



FN001 (M6) x 16

MS259L x 1

PS090 x 1

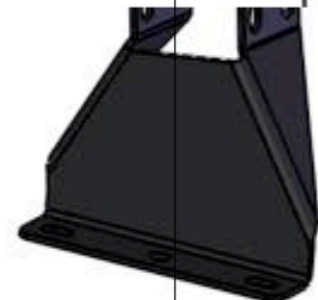

FS059 (M8 x 25) x 22



FN023 (M8) x 22



13mm x 2

10mm x 2

MS260R x 1

MS019 x 6

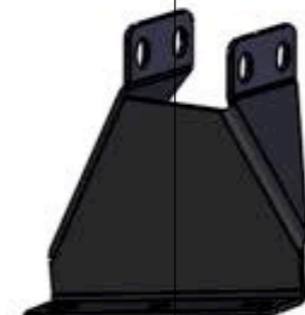

FT01 x 1

?

PS046 x 8

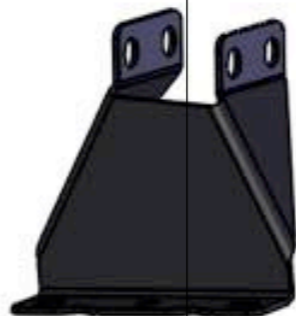

MS260L x 1

